

# Coated Pipe System Catalogue

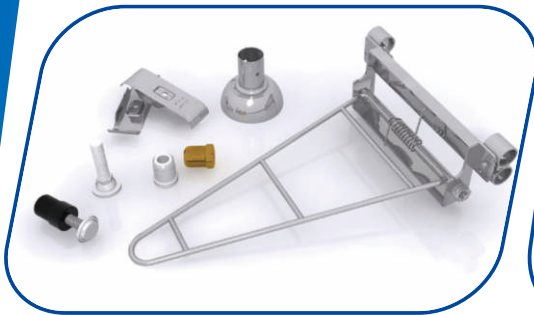
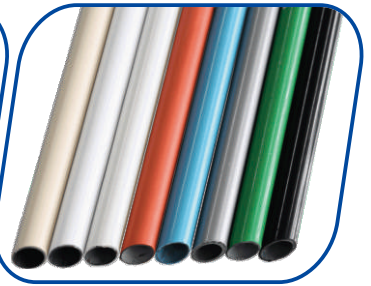

**King 9 Technology Company Limited**

# 公司概况

## COMPANY INFORMATION

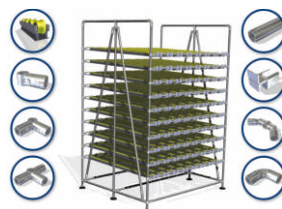

深圳市金久精益科技有限公司是一家专业销售DIY精益产品及其系列产品的公司，本公司主要以OEM商品化为目的进行产品开发，公司秉承以客户需求为核心，快速准确的为客户提供高品质产品和服务。公司通过独自设计汇编产品目录，建立起直接销售产品的营销体制，根据客户的建议和要求，制定产品和服务规划，并持续开发提供高质量水平的金久产品。

DIY，简称DO IT YOURSELF，它因人们的需要而存在，在企业中它提高企业的工作效率，为企业节省成本，在生活中它不仅可以满足人们的需求，而且能提高人们生活的热情和人们的动手操作能力，随着社会经济水平的不断提高，社会变化日新月异，同时社会也对DIY行业给予了高度关注，金久将一如既往地积极投身于此领域。

King 9 Technology Company Limited is a professional Company which sales of DIY products and related products. the company mainly take "OEM commercialization" as purpose of product development,the company adhering to customer needs as the core, providing customers with high quality products and services timely and accurate.King 9 has own product catalog and a direct sales marketing system,according to the recommenda-tions and requirements of the customers to make products and services. We will continue to do better.

### 企业理念 Our Philosophy





经营理念：敬诚守信 和谐高效  
人才理念：敬贤礼士 才尽其用  
创新理念：超越自我 因时而变  
服务理念：尊重需求 尽善尽美  
学习理念：敬学善用 共同成长  
投资理念：注重价值 规避风险  
安全理念：敬畏生命 细节至上  
风险理念：驾驭风险 科学发展  
廉洁理念：敬廉正直 干净干事

### 企业使命 Our Mission

推动DIY精益生活领域发展和创新，保持金久精益在DIY精益生活领域与技术领域的领先地位，对行业技术进步具有导向性，对产业发展具有推动性。为创造高品质的美好生活搭建平台，促进经济的繁荣与发展，达成与社会的和谐共荣，持续塑造一个充满活力、高度负责永续经营的长青企业。

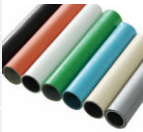
- 01 复合管系列  
Coated Pipe
- 02 五金接头系列  
Metal Joint(Set)
- 08 铁滑轨  
Steel Roller placon
- 09 铝滑轨  
Aluminum roller placon
- 10 铝滑轨接头  
Aluminum Roller Bracket
- 11 铁滑轨接头  
Steel Roller Bracket
- 12 滑动管接头  
Slide Pipe Braket
- 13 塑胶接头  
Plastic Joint
- 14 脚杯/脚轮系列  
Adjust foot and Caster
- 16 附件  
Tube Accessory

## 复合管 Coated Pipe ( 28mm )

Item number	Photo	Dimension	Weight	Capacity	MOQ	Material	Standard Length	Color
		(mm)	(g/meter)	(kg/m)	(pcs)		(mm)	
KJ-2807		φ28*0.7	505	45	⊙	Coated Pipe	4000	IV:Ivory WH:White SB:Sky blue DB:Dark Blue RE:Red GR:Green YE:Yellow BE:Beige LG:Light Gray BK:Black
KJ-2808		φ28*0.8	550	78	⊙			
KJ-2810		φ28*1.0	700	100	⊙			
KJ-2812		φ28*1.2	800	120	500			
KJ-2815		φ28*1.5	1000	150	1000			
KJ-2820		φ28*2.0	1300	200	500			
KJ-2807ESD		φ28*0.7	505	45	⊙	Coated Pipe	4000	EB:Esd Black ※LG:Gray
KJ-2808ESD		φ28*0.8	550	78	⊙			
KJ-2810ESD		φ28*1.0	700	100	⊙			
KJ-2812ESD		φ28*1.2	800	120	500			
KJ-2815ESD		φ28*1.5	1000	150	1000			
KJ-2820ESD		φ28*2.0	1300	200	500			
KJ-2810SLIDE		φ28*1.0	770	100	750	Coated Pipe	4000	BE:Beige
KJ-2807S		φ28*0.7	500	40	500	SUS430 SUS439 SUS201 SUS304	4000	/
KJ-2808S		φ28*0.8	525	73	500			
KJ-2810S		φ28*1.0	670	90	500			
KJ-2812S		φ28*1.2	780	110	750			
KJ-2812AL		φ28*1.2	375	60	750	Aluminum pipe	4000/6000	Bright gray
KJ-2820AL		φ28*2.0	520	90	750			

Standard color of coated pipe : Ivory,White,Sky Blue,Dark Blue,Red,Green,Yellow, Beige,Light Grey, Black

※.If have special color, we can do it according customer sample, The MOQ is 1000PCS

※"/" means no this product,"⊙" means accept any quantity.

## 复合管 Coated Pipe ( 28.6mm )

Item number	Photo	Dimension	Weight	Capacity	MOQ	Material	Standard Length	Color
		(mm)	(g/meter)	(kg/m)	(pcs)		(mm)	
KJ-3007		φ28.6*0.7	505	45	⊙	Coated Pipe	4000	IV:Ivory WH:White SB:Sky blue DB:Dark Blue RE:Red GR:Green YE:Yellow BE:Beige LG:Light Gray BK:Black
KJ-3008		φ28.6*0.8	550	78	⊙			
KJ-3010		φ28.6*1.0	700	100	⊙			
KJ-3012		φ28.6*1.2	800	120	500			
KJ-3015		φ28.6*1.5	1000	150	1000			
KJ-3020		φ28.6*2.0	1300	200	500			
KJ-3007ESD		φ28.6*0.7	505	45	⊙	Coated Pipe	4000	EB:Esd Black ※LG:Gray
KJ-3008ESD		φ28.6*0.8	550	78	⊙			
KJ-3010ESD		φ28.6*1.0	700	100	⊙			
KJ-3012ESD		φ28.6*1.2	800	120	500			
KJ-3015ESD		φ28.6*1.5	1000	150	1000			
KJ-3020ESD		φ28.6*2.0	1300	200	500			

Standard color of coated pipe : Ivory,White,Sky Blue,Dark Blue,Red,Green,Yellow, Beige,Light Grey, Black

※.If have special color, we can do it according customer sample, The MOQ is 1000PCS

※"/" means no this product,"⊙" means accept any quantity.

## 五金接头 Metal Joint(single)



Item NO.	Material	Color code	Weight(g)	QTY(pcs)	Package(cm)	Item NO.	Material	Color code	Weight(g)	QTY(pcs)	Package(cm)
K-1	SPCC	BK,ZN,CN	70	300	26*21*18.5	K-6A	SPCC	BK,ZN,CN	70	300	26*21*18.5
	SUS304	Original					/	/			
K-1A	SPCC	BK,ZN,CN	68	300	26*21*18.5	K-7	SPCC	BK,ZN,CN	50	200	26*21*16
	SUS304	Original					SUS304	Original			
K-2	SPCC	BK,ZN,CN	110	200	26*21*18.5	K-7A	SPCC	BK,ZN,CN	45	200	26*21*16
	SUS304	Original					SUS304	Original			
K-3	SPCC	BK,ZN,CN	120	100	26*21*18.5	K-8	SPCC	BK,ZN,CN	70	150	26*21*18.5
	SUS304	Original					SUS304	Original			
K-3A	SPCC	BK,ZN,CN	120	100	26*21*18.5	K-8A	SPCC	BK,ZN,CN	72	150	26*21*18.5
	SUS304	Original					/	/			
K-4	SPCC	BK,ZN,CN	122	200	26*21*18.5	K-8B	SPCC	BK,ZN,CN	75	150	26*21*18.5
	SUS304	Original					/	/			
K-5	SPCC	BK,ZN,CN	55	300	26*21*18.5	K-9	SPCC	BK,ZN,CN	70	150	26*21*18.5
	SUS304	Original					SUS304	Original			
K-6	SPCC	BK,ZN,CN	65	300	26*21*18.5						
	SUS304	Original									

五金接头  
Metal Joint(single)



Item NO.	Material	Color code	Weight(g)	QTY(pcs)	Package(cm)	Item NO.	Material	Color code	Weight(g)	QTY(pcs)	Package(cm)
K-10A	SPCC	BK,ZN,CN	72	200	26*21*18.5	K-13A	SPCC	BK,ZN,CN	52	300	26*21*18.5
	SUS304	Original					SUS304	Original			
K-10B	SPCC	BK,ZN,CN	72	200	26*21*18.5	K-14	SPCC	BK,ZN,CN	65	200	26*21*18.5
	SUS304	Original					SUS304	Original			
K-11	SPCC	BK,ZN,CN	100	150	26*21*18.5	K-15	SPCC	BK,ZN,CN	45	400	26*21*18.5
	SUS304	Original					SUS304	Original			
K-11A	SPCC	BK,ZN,CN	110	150	26*21*18.5	K-16	SPCC	BK,ZN,CN	50	400	26*21*18.5
	/	/					SUS304	Original			
K-11B	SPCC	BK,ZN,CN	110	150	26*21*18.5	K-17	SPCC	BK,ZN,CN	65	300	26*21*18.5
	/	/					SUS304	Original			
K-11C	SPCC	BK,ZN,CN	110	200	26*21*18.5	K-18	SPCC	BK,ZN,CN	65	300	26*21*18.5
	/	/					/	/			
K-12	SPCC	BK,ZN,CN	70	200	26*21*18.5	K-19	SPCC	BK,ZN,CN	70	250	26*21*18.5
	SUS304	Original					/	/			
K-13	SPCC	BK,ZN,CN	55	300	26*21*18.5						
	SUS304	Original									

## 五金接头 Metal Joint(single)



Item NO.	Material	Color code	Weight(g)	QTY(pcs)	Package(cm)	Item NO.	Material	Color code	Weight(g)	QTY(pcs)	Package(cm)
K-20	SPCC	BK,ZN,CN	122	150	26*21*18.5	K-28	SPCC	BK,ZN,CN	68	200	26*21*18.5
	SUS304	Original					/	/			
K-21	SPCC	BK,ZN,CN	98	100	26*21*18.5	K-29	SPCC	BK,ZN,CN	72	200	26*21*18.5
	/	/					/	/			
K-22	SPCC	BK,ZN,CN	70	100	26*21*18.5	K-30	SPCC	BK,ZN,CN	78	150	26*21*18.5
	/	/					/	/			
K-23	SPCC	BK,ZN,CN	68	300	26*21*18.5	K-31	SPCC	BK,ZN,CN	85	200	26*21*18.5
	/	/					/	/			
K-24	SPCC	BK,ZN,CN	75	250	26*21*18.5	K-32	SPCC	BK,ZN,CN	35	150	26*21*18.5
	/	/					/	/			
K-25	SPCC	BK,ZN,CN	82	200	26*21*18.5	K-33	SPCC	BK,ZN,CN	55	300	26*21*18.5
	/	/					/	/			
K-26	SPCC	BK,ZN,CN	98	300	26*21*18.5	K-34	SPCC	BK,ZN,CN	65	300	26*21*18.5
	/	/					/	/			
K-27	SPCC	BK,ZN,CN	82	300	26*21*18.5						
	/	/									

五金接头  
Metal Joint(single)

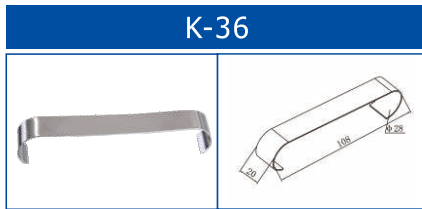
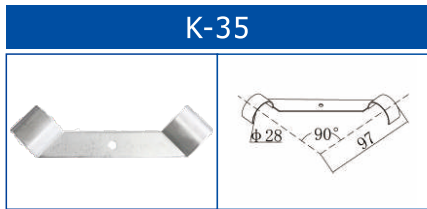

Item NO.	Material	Color code	Weight(g)	QTY(pcs)	Package(cm)	Item NO.	Material	Color code	Weight(g)	QTY(pcs)	Package(cm)
K-35	SPCC	BK,ZN,CN	115	200	26*21*18.5	K-41	SPCC	BK,ZN,CN	110	200	26*21*18.5
	/	/					/				
K-36	SPCC	BK,ZN,CN	20	200	26*21*18.5	K-42	SPCC	BK,ZN,CN	89	200	26*21*18.5
	/	/					/				
K-37	SPCC	BK,ZN,CN	10	500	26*21*18.5	K-43	SPCC	BK,ZN,CN	89	200	26*21*18.5
	/	/					/				
K-38	SPCC	BK,ZN,CN	55	200	26*21*18.5	K-44	SPCC	BK,ZN,CN	85	200	26*21*18.5
	/	/					/				
K-39	SPCC	BK,ZN,CN	65	200	26*21*18.5	K-45	SPCC	BK,ZN,CN	45	200	26*21*18.5
	/	/					/				
K-40	SPCC	BK,ZN,CN	100	200	26*21*18.5	K-46	SPCC	BK,ZN,CN	55	200	26*21*18.5
	/	/					/				

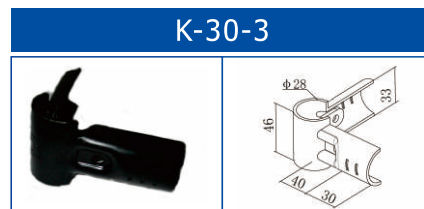
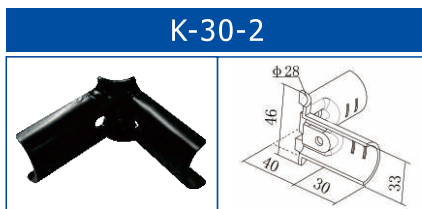

Item NO.	Material	Color code	Weight(g)	QTY(pcs)	Package(cm)	Item NO.	Material	Color code	Weight(g)	QTY(pcs)	Package(cm)
K30-1	SPCC	BK,ZN,CN	100	200	26*21*20	K-30-3	SPCC	BK,ZN,CN	145	50	26*21*15
	/	/					/				
K30-2	SPCC	BK,ZN,CN	120	100	26*21*15						
	/	/									



## 五金接头 Metal Joint(Set)

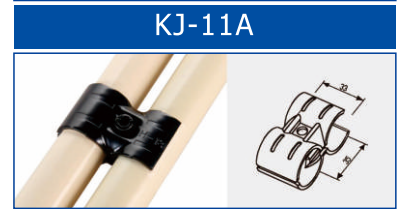
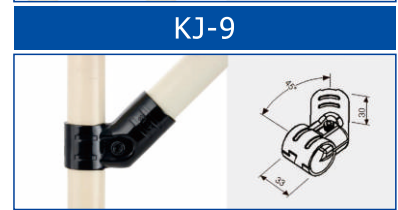
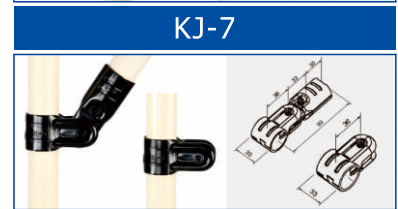
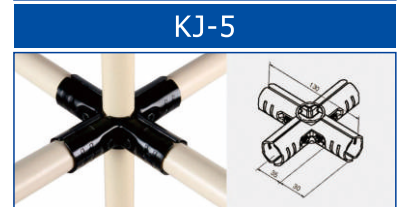
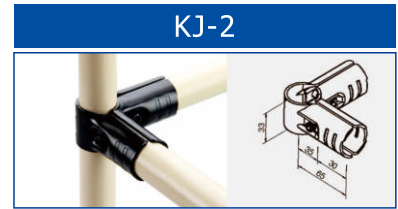
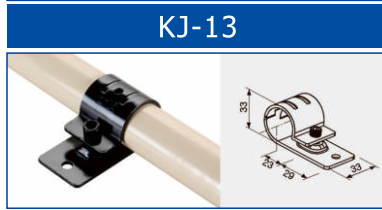
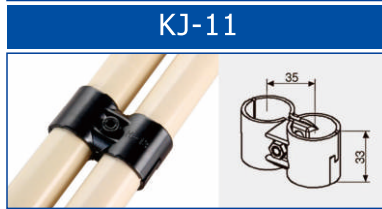
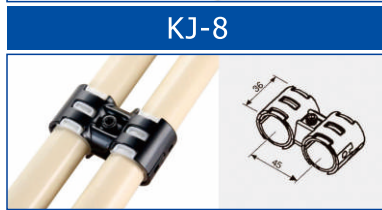
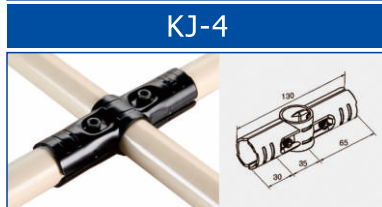
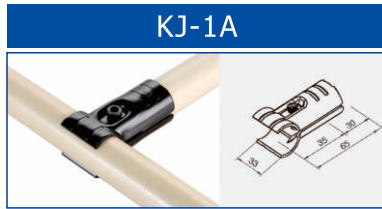
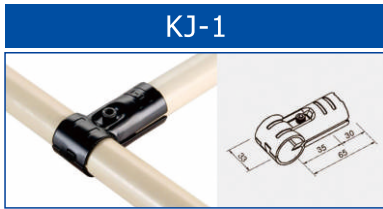

Item NO.	Assembly (pcs)	Bolt Nut (set)	QTY (set)
KJ-1	K-1*2	M6*25	1
KJ-1A	K-1A*2	M6*25	1
KJ-2	K-2*1+K-3*1	M6*25	2
KJ-3	K-2*2+K-4*1	M6*25	3
KJ-4	K-4*2	M6*25	2
KJ-5	K-2*4	M6*25	4
KJ-6	K-7*2	M6*25	1

Item NO.	Assembly (pcs)	Bolt Nut (set)	QTY (set)
KJ-6A	K-7A*2	M6*25	1
KJ-7	K-5*2+K-6*2	M6*25	2
KJ-7A	K-6A*4	M6*25	2
KJ-8	K-9*2+K-140*2	M6*25	1
KJ-9	K-10A*1+K-10B*1	M6*25	1
KJ-10	K-12*2+K-140*1	M6*25	1
KJ-11	K-13*2	M6*25	1

Item NO.	Assembly (pcs)	Bolt Nut (set)	QTY (set)
KJ-11A	K-13A*2	M6*25	1
KJ-12	K-6*4+K-14*2	M6*25	4
KJ-13	K-15*1+K-16*1	M6*12	1
KJ-14	K-8*2	M6*25	1
KJ-14A	K-8A*2	M6*25	1
KJ-14B	K-8B*2	M6*25	1
KJ-15	K-39*2	M6*25	1

五金接头  
Metal Joint(Set)

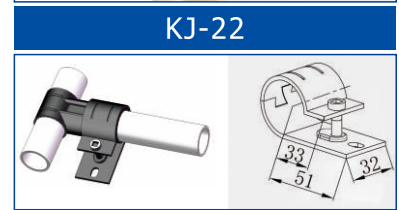
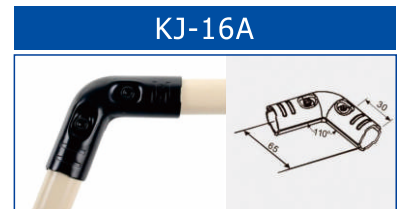
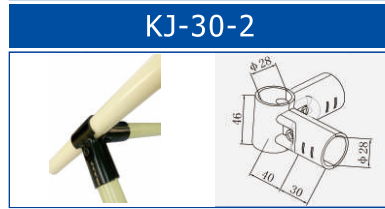
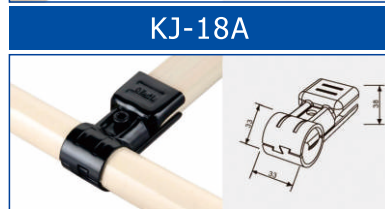
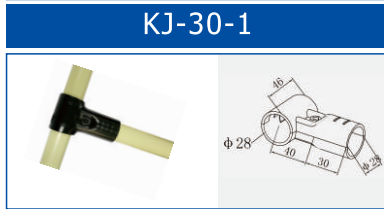
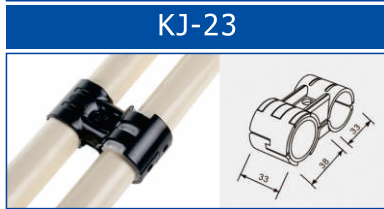
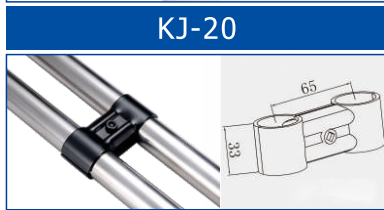

Item NO.	Assembly (pcs)	Bolt Nut (set)	QTY (Set)
KJ-15A	K-39*1+K-46*1	M6*25	1
KJ-16	K-11*2	M6*25	2
KJ-16A	K-11A*2	M6*25	2
KJ-16B	K-11B*2	M6*25	2
KJ-16C	K-11C*2	M6*25	2
KJ-17	K-17*2	M6*25	1
KJ-18	K-44*2	M6*25	1

Item NO.	Assembly (pcs)	Bolt Nut (set)	QTY (Set)
KJ-18A	K-44*1+K-1*1	M6*25	1
KJ-19	K-20*2	M6*25	1
KJ-20	K-26*2	M6*25	1
KJ-21	K-27*2	M6*25	1
KJ-22	K-33*1+K-34*1+K-140*1	M6*25	1
KJ-23	K-31*2+K-140*1	M6*25	1
KJ-24	K-40*2+K-140*1	M6*25	2

Item NO.	Assembly (pcs)	Bolt Nut (set)	QTY (set)
KJ-25	K-41*2	M6*25	2
KJ-26	K-42*2	M6*25	1
KJ-27	K-43*2	M6*12	1
KJ-30-1	K30-1*2	M6*25	1
KJ-30-2	K30-2*1+K30-3*1	M6*25	2

## 铁滑轨 Steel roller placon

### KJ-2035A

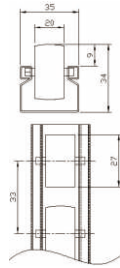
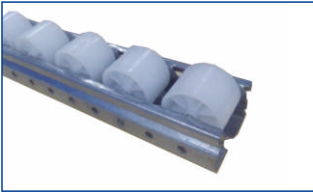

OD of wheel/轮径	27mm	Material/材质	steel/铁
L.W/长度.宽度	4000mm.35mm	Color/颜色	white/yellow/esd black 白色/黄色/防静电黑色
Weight/重量	0.7kg/m	Package/每箱	6pcs

### KJ-2035B

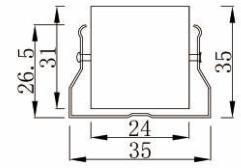

OD of wheel/轮径	31mm	Material/材质	steel/铁
L.W/长度.宽度	4000mm.35mm	Color/颜色	white/yellow/esd black 白色/黄色/防静电黑色
Weight/重量	0.78kg/m	Package/每箱	6pcs

### KJ-2046A

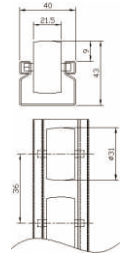
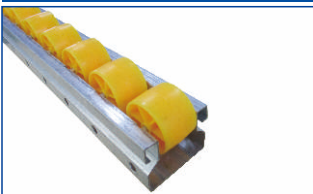

OD of wheel/轮径	31mm	Material/材质	steel/铁
L.W/长度.宽度	4000mm.40mm	Color/颜色	white/yellow/esd black 白色/黄色/防静电黑色
Weight/重量	1.07kg/m	Package/每箱	6pcs

### KJ-2046B

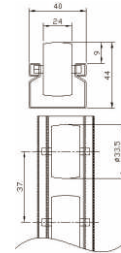

OD of wheel/轮径	34mm	Material/材质	steel/铁
L.W/长度.宽度	4000mm.40mm	Color/颜色	white/yellow/esd black 白色/黄色/防静电黑色
Weight/重量	1.17kg/m	Package/每箱	6pcs

### KJ-2046C

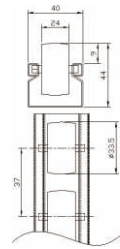

OD of wheel/轮径	34mm	Material/材质	steel/铁
L.W/长度.宽度	4000mm.40mm	Color/颜色	white/yellow/esd black 白色/黄色/防静电黑色
Weight/重量	1.15kg/m	Package/每箱	6pcs

### KJ-2047

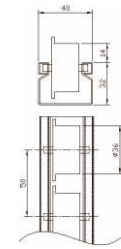

OD of wheel/轮径	35mm	Material/材质	steel/铁
L.W/长度.宽度	4000mm.40mm	Color/颜色	white/yellow/esd black 白色/黄色/防静电黑色
Weight/重量	1.1kg/m	Package/每箱	6pcs

### KJ-2049

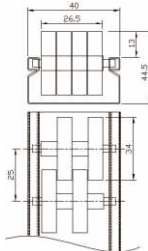

OD of wheel/轮径	34mm	Material/材质	steel/铁
L.W/长度.宽度	4000mm.40mm	Color/颜色	white/yellow/esd black 白色/黄色/防静电黑色
Weight/重量	1.0kg/m	Package/每箱	6pcs

### KJ-2060A

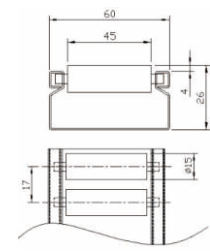

OD of wheel/轮径	15mm	Material/材质	steel/铁
L.W/长度.宽度	4000mm.60mm	Color/颜色	white/yellow/esd black 白色/黄色/防静电黑色
Weight/重量	1.2kg/m	Package/每箱	6pcs

### KJ-2060B

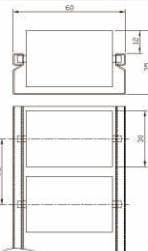

OD of wheel/轮径	30mm	Material/材质	steel/铁
L.W/长度.宽度	4000mm.60mm	Color/颜色	white/yellow/esd black 白色/黄色/防静电黑色
Weight/重量	1.35kg/m	Package/每箱	6pcs

## 铁滑轨 Steel roller placon

KJ-2085A

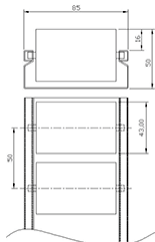

OD of wheel/轮径	34mm	Material/材质	steel/铁
L.W/长度.宽度	4000mm.85mm	Color颜色	white/yellow/esd black 白色/黄色/防静电黑色
Weight/重量	2.3kg/m	Package/每箱	4pcs

KJ-2085B

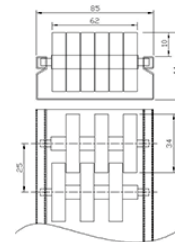

OD of wheel/轮径	34mm	Material/材质	steel/铁
L.W/长度.宽度	4000mm.85mm	Color颜色	white/yellow/esd black 白色/黄色/防静电黑色
Weight/重量	2.4kg/m	Package/每箱	4pcs

KJ-2048

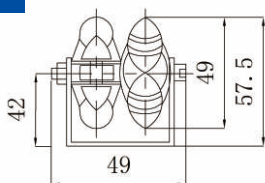

OD of wheel/轮径	49mm	Material/材质	steel/铁
L.W/长度.宽度	1000mm	Color颜色	yellow/blue 黄色/蓝色
Weight/重量	4.5kg/m	Package/每箱	4pcs

KJ-2048A

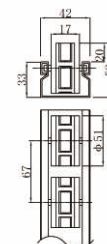

OD of wheel/轮径	51mm	Material/材质	steel/铁
L.W/长度.宽度	1000mm	Color颜色	yellow/blue 黄色/蓝色
Weight/重量	1.4kg/m	Package/每箱	4pcs

## 铝滑轨 Aluminum roller placon

KJ-2045A

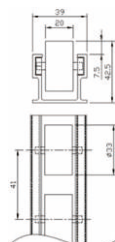
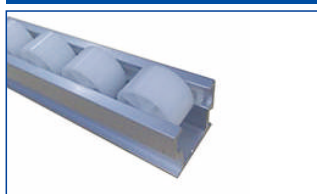

OD of wheel/轮径	33mm	Material/材质	Aluminum/铝
L.W/长度.宽度	4000mm.40mm	Color颜色	white/yellow/esd black 白色/黄色/防静电黑色
Weight/重量	0.7kg/m	Package/每箱	4pcs

KJ-2045B

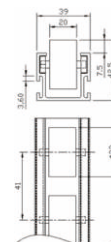

OD of wheel/轮径	33mm	Material/材质	Aluminum/铝
L.W/长度.宽度	4000mm.40mm	Color颜色	white/yellow/esd black 白色/黄色/防静电黑色
Weight/重量	0.9kg/m	Package/每箱	4pcs

KJ-2045C

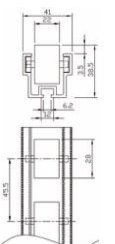

OD of wheel/轮径	28mm	Material/材质	Aluminum/铝
L.W/长度.宽度	4000mm.40mm	Color颜色	white/yellow/esd black 白色/黄色/防静电黑色
Weight/重量	0.7kg/m	Package/每箱	4pcs

KJ-2045D

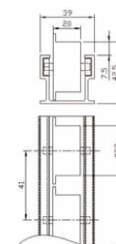

OD of wheel/轮径	34mm	Material/材质	Aluminum/铝
L.W/长度.宽度	4000mm.40mm	Color颜色	white/yellow/esd black 白色/黄色/防静电黑色
Weight/重量	0.8kg/m	Package/每箱	4pcs

## 铝滑轨 Aluminum roller placon

KJ-2045E

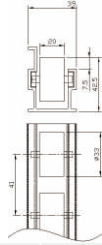
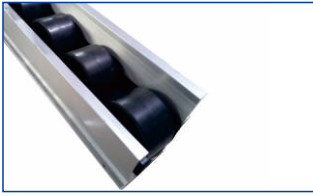

OD of wheel/轮径	34mm	Material/材质	Aluminum/铝
L.W/长度.宽度	4000mm.40mm	Color颜色	white/yellow/esd black 白色/黄色/防静电黑色
Weight/重量	0.8kg/m	Package/每箱	4pcs

KJ-2045F

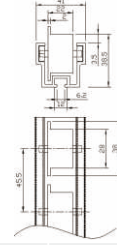
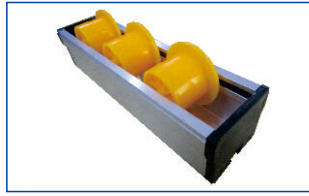

OD of wheel/轮径	28mm	Material/材质	Aluminum/铝
L.W/长度.宽度	4000mm.40mm	Color颜色	white/yellow/esd black 白色/黄色/防静电黑色
Weight/重量	0.6kg/m	Package/每箱	4pcs

KJ-2045-60

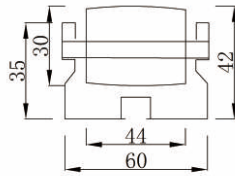

OD of wheel/轮径	30mm	Material/材质	Aluminum/铝
L.W/长度.宽度	4000mm.60mm	Color颜色	white/yellow/esd black 白色/黄色/防静电黑色
Weight/重量	1.22kg/m	Package/每箱	4pcs

KJ-2045-72

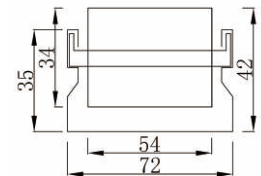

OD of wheel/轮径	34mm	Material/材质	Aluminum/铝
L.W/长度.宽度	4000mm.72mm	Color颜色	white/yellow/esd black 白色/黄色/防静电黑色
Weight/重量	1.25kg/m	Package/每箱	4pcs

## 铝滑轨接头 Aluminum Roller Bracket

KJ-2044C(Zinc/Nickel/Chrome)

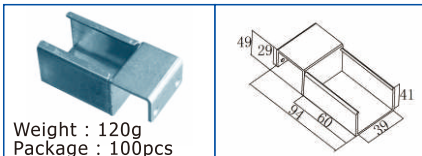

KJ-2044D(Zinc/Nickel/Chrome)

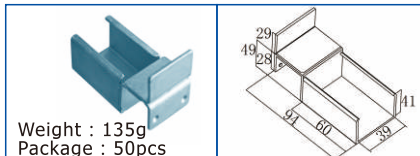

KJ-2044DW(Zinc/Nickel/Chrome)

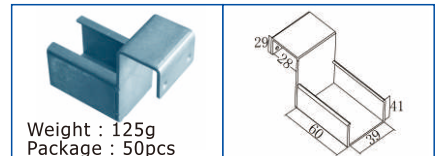

KJ-2044E(Zinc/Nickel/Chrome)

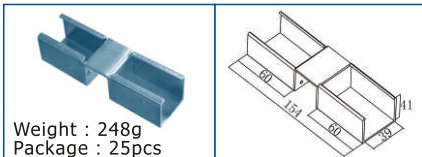

KJ-2044EF(Zinc/Nickel/Chrome)

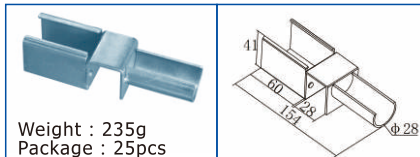

KJ-2044P(Zinc/Nickel/Chrome)

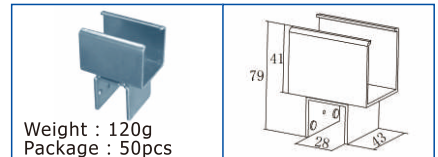

KJ-2044EE(Zinc/Nickel/Chrome)

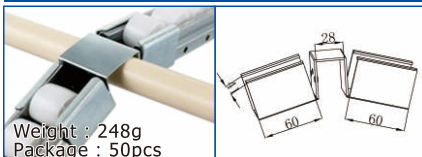

KJ-2044EP(Zinc/Nickel/Chrome)

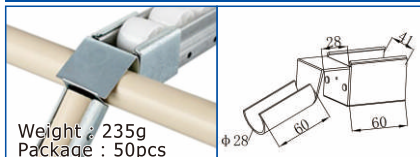

KJ-2040EG(Zinc/Nickel/Chrome)

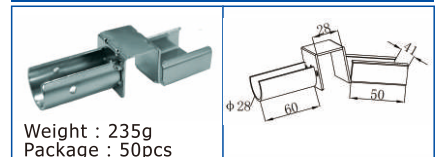

**铁滑轨接头**  
**Steel Roller Bracket**

**KJ-2035C-A(Zinc/Nickel/Chrome)**

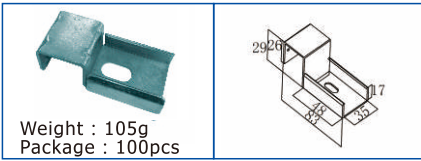

**KJ-2035D-A(Zinc/Nickel/Chrome)**

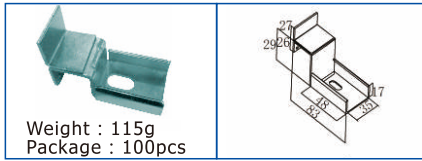

**KJ-2035DW-A(Zinc/Nickel/Chrome)**

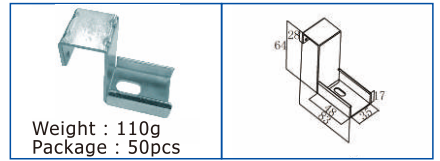

**KJ-2035E-A(Zinc/Nickel/Chrome)**

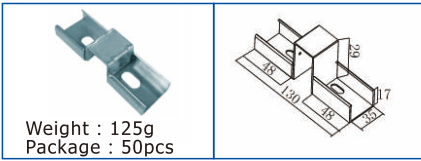

**KJ-2035P(Zinc/Nickel/Chrome)**

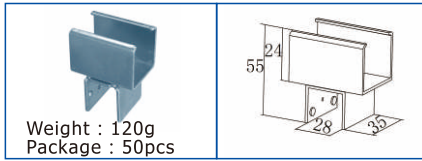

**KJ-2035C-B(Zinc/Nickel/Chrome)**

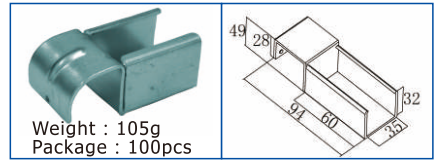

**KJ-2035DW-B(Zinc/Nickel/Chrome)**

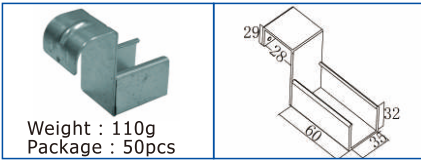

**KJ-2040C(Zinc/Nickel/Chrome)**

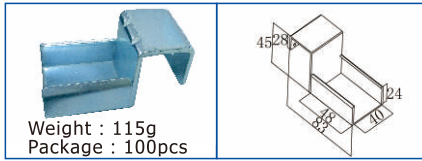

**KJ-2040D(Zinc/Nickel/Chrome)**

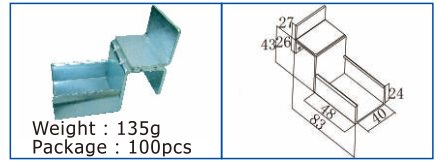

**KJ-2040DW(Zinc/Nickel/Chrome)**

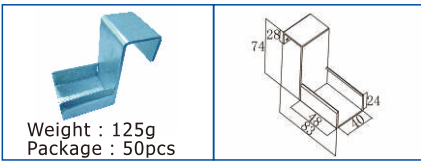

**KJ-2040E(Zinc/Nickel/Chrome)**

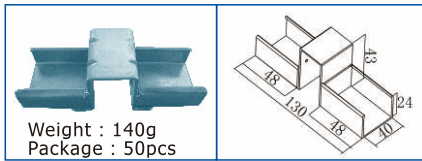

**KJ-2040EE(Zinc/Nickel/Chrome)**

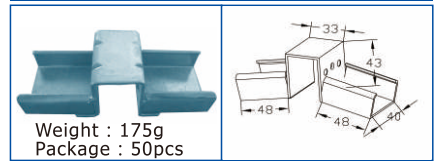

**KJ-2040EF(Zinc/Nickel/Chrome)**

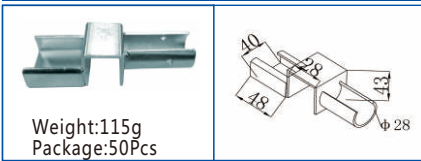

**KJ-2040EP(Zinc/Nickel/Chrome)**

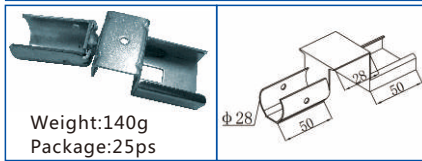

**KJ-2040P(Zinc/Nickel/Chrome)**

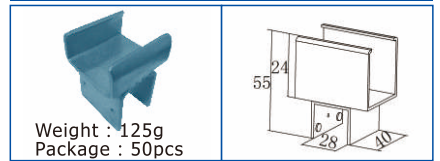

**KJ-2040U(Zinc/Nickel/Chrome)**

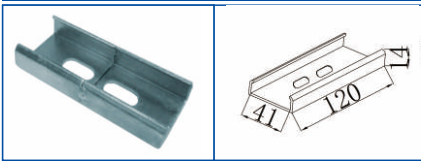

**KJ-2060C-A(Zinc/Nickel/Chrome)**

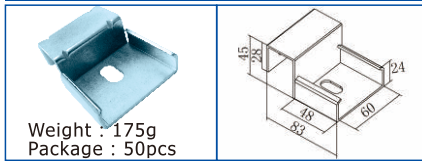

**KJ-2060D-A(Zinc/Nickel/Chrome)**

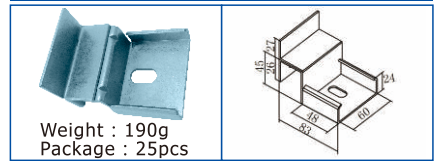

**KJ-2060DW-A(Zinc/Nickel/Chrome)**

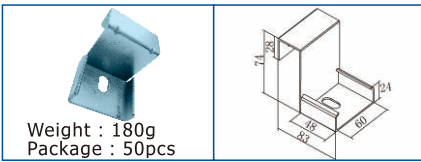

**KJ-2060E-A(Zinc/Nickel/Chrome)**

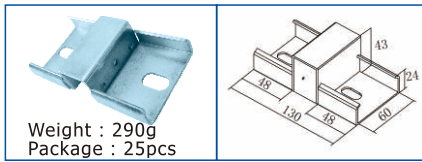

**KJ-2060P-A(Zinc/Nickel/Chrome)**

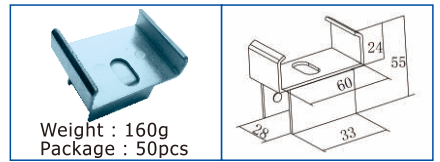

**KJ-2060C-B(Zinc/Nickel/Chrome)**

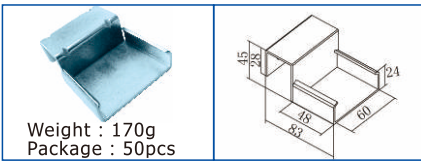

**KJ-2060D-B(Zinc/Nickel/Chrome)**

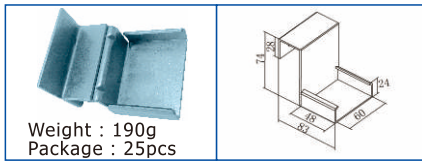

**KJ-2060DW-B(Zinc/Nickel/Chrome)**

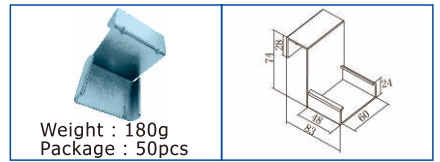

## 铁滑轨接头 Steel Roller Bracket

KJ-2060E-B(Zinc/Nickel/Chrome)

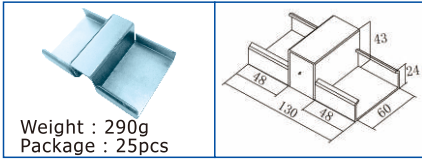

KJ-2060P-B(Zinc/Nickel/Chrome)

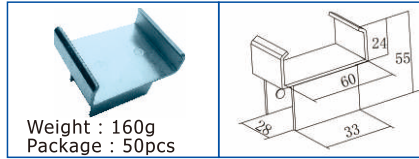

KJ-2085C(Zinc/Nickel/Chrome)

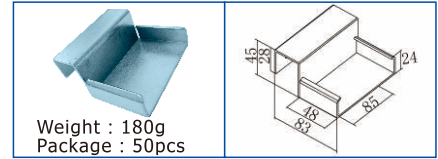

KJ-2085D(Zinc/Nickel/Chrome)

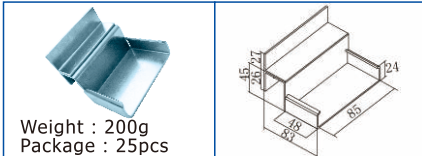

KJ-2085DW(Zinc/Nickel/Chrome)

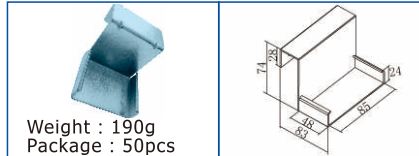

KJ-2085E(Zinc/Nickel/Chrome)

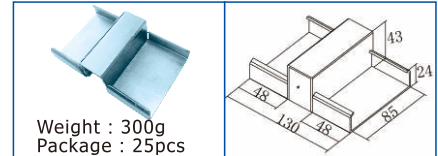

KJ-2085P(Zinc/Nickel/Chrome)

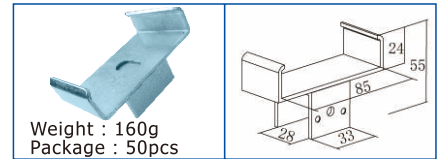

## 滑动管接头 Slide Pipe Bracket

KJ-2044CF(Zinc/Nickel/Chrome)

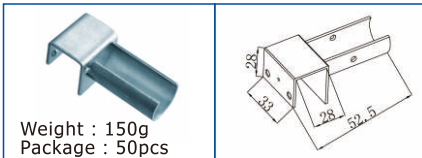

KJ-2044DF(Zinc/Nickel/Chrome)

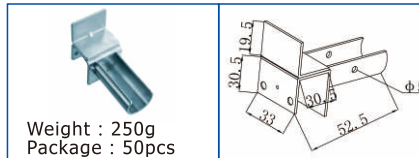

KJ-2044WF(Zinc/Nickel/Chrome)

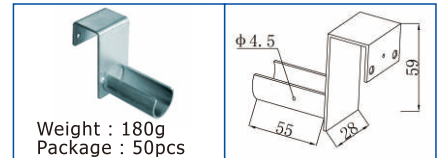

KJ-2044EH(Zinc/Nickel/Chrome)

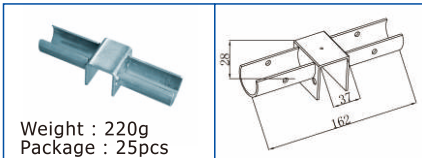

KJ-2044EC(Zinc/Nickel/Chrome)

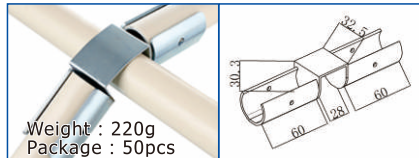

KJ-2044PF(Zinc/Nickel/Chrome)

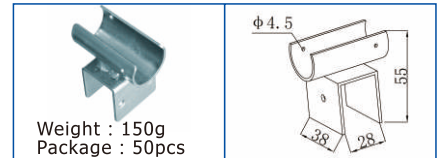

KJ-2044FF(Zinc/Nickel/Chrome)

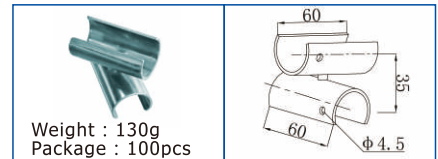

## 配40铝型材接头 Roller Bracket for Aluminum

KJ-2040C-40

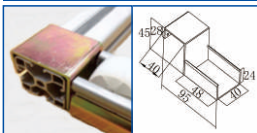

KJ-2040D-40

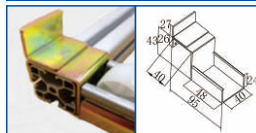

KJ-2040DD-40

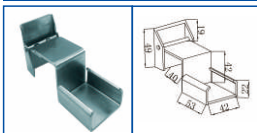

KJ-2040DW-40

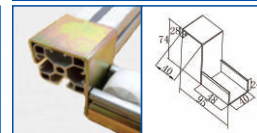

KJ-2040E-40

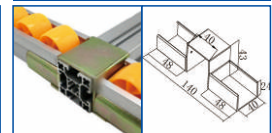

KJ-2044C-40

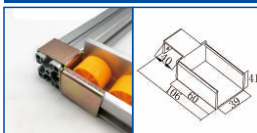

KJ-2044DW-40

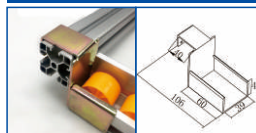

KJ-2060C-40

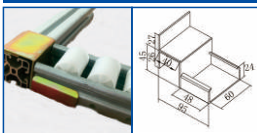



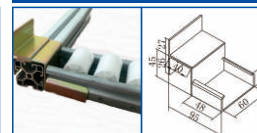

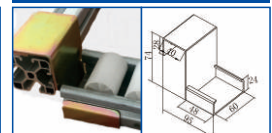

KJ-2060D-40

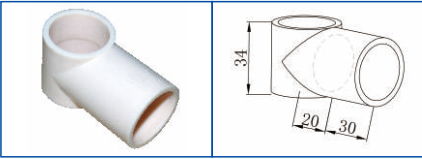
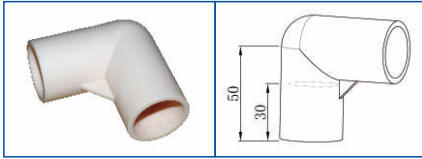
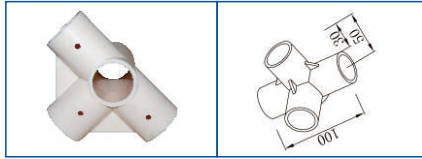
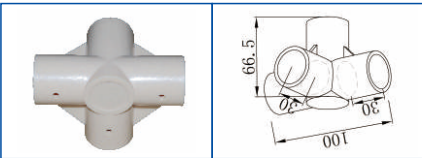
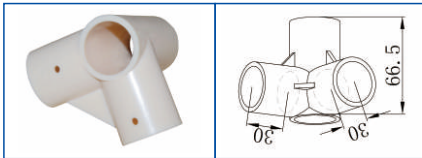
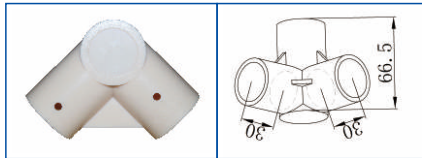
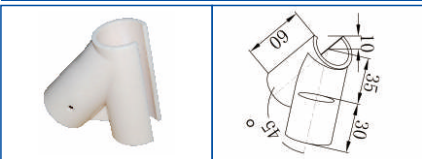
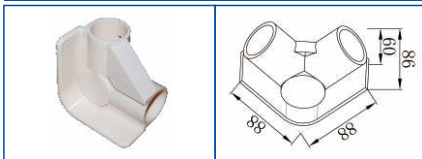
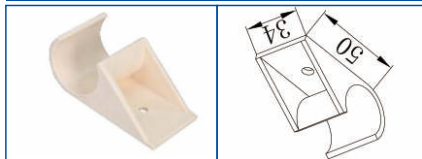
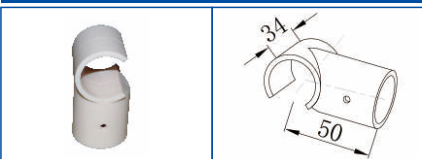
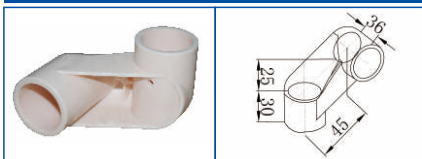
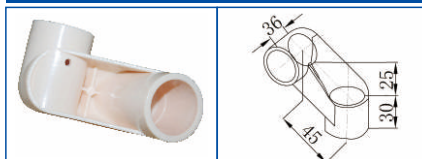
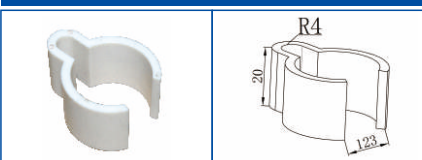
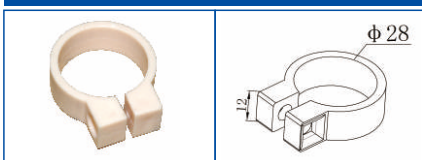

KJ-2060DW-40

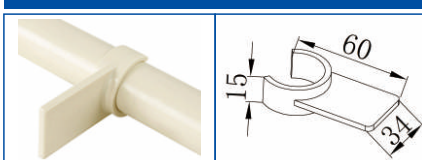
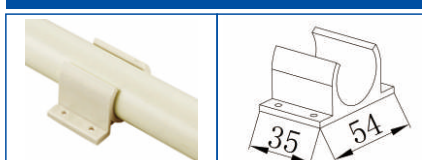
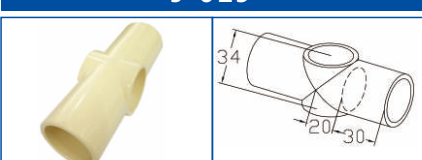

塑胶接头  
Plastic Joint

<p>J-001</p> 	<p>J-002</p> 	<p>J-003</p> 
<p>J-003A</p> 	<p>J-004</p> 	<p>J-004A</p> 
<p>J-005</p> 	<p>J-006</p> 	<p>J-007</p> 
<p>J-008</p> 	<p>J-009R</p> 	<p>J-009L</p> 
<p>J-010</p> 	<p>J-011</p> 	<p>J-012</p> 
<p>J-013</p> 	<p>J-014</p> 	<p>J-015</p> 
<p>J-016</p> 	<p>J-017</p> 	<p>J-018</p> 
<p>J-019</p> 		



## 脚杯/脚轮系列 Adjust foot and Caster

### Fixed Caster Series

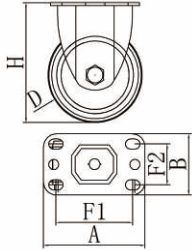

### Attaching Caster Series

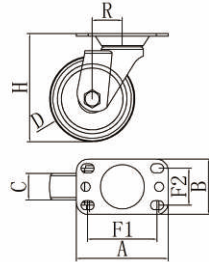

### Insertion Caster Series

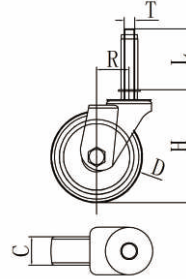

### Bushing Caster Series

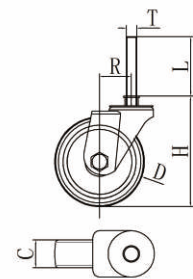

### 01 固定脚轮系列 Fixed Caster Series

FIXED 固定	轮径D (mm)	底板尺寸 A*B	Material 轮子材质	Frame Material 支架材质	Offset DisancePIA 偏心距R(mm)	Loading 承重 (N)	High/高度 H(mm)	Weight 单重 (g)	Package 每箱 ( pcs )
KJ-301	75mm	70*60	pvc/pu/rubber	steel	/	800	95	450	50
KJ-301-ESD			rubber/tp		/				
KJ-401	100mm	90*100	pvc/pu/rubber		/	1200	132	550	40
KJ-401-ESD			rubber/tp		/				
KJ-501	125mm	120*110	pvc/pu/rubber		/	1600	190	750	30
KJ-501-ESD			rubber/tp	/					

### 02 平板脚轮系列 Attaching Caster Series

Without Brake 不带刹	Brake 带刹	轮径D (mm)	底板尺寸 A*B	Material 轮子材质	Frame Material 支架材质	Offset DisancePIA 偏心距R(mm)	Loading 承重 (N)	High/高 度H(mm)	Weight 单重 (g)	Package 每箱 ( pcs )
KJ-302A	KJ-302B	75mm	70*60	pvc/pu/rubber	steel	35	800	95	630/730	50
KJ-302A-ESD	KJ-302B-ESD			rubber/tp		35				
KJ-402A	KJ-402B	100mm	90*100	pvc/pu/rubber		32	1200	132	740/910	40
KJ-402A-ESD	KJ-402B-ESD			rubber/tp		32				
KJ-502A	KJ-502B	125mm	120*110	pvc/pu/rubber		32	1600	190	900/1050	30
KJ-502A-ESD	KJ-502B-ESD			rubber/tp	32					

### 03 插杆脚轮系列 Insertion Caster Series

Without Brake 不带刹	Brake 带刹	轮径D (mm)	丝杆外径 T	Material 轮子材质	Frame Material 支架材质	Offset DisancePIA 偏心距R(mm)	Loading 承重 (N)	长度 L(mm)	High/高 度H(mm)	Weight 单重 (g)	Package 每箱 ( pcs )
KJ-303A	KJ-303B	75mm	M12*60	pvc/pu/rubber	steel	35	500	60	95	480/580	50
KJ-303A-ESD	KJ-303B-ESD			rubber/tp		35					
KJ-403A	KJ-403B	100mm	M12*60	pvc/pu/rubber		32	600	60	132	630/780	40
KJ-403A-ESD	KJ-403B-ESD			rubber/tp		32					
KJ-503A	KJ-503B	125mm	M12*60	pvc/pu/rubber		32	1000	60	190	900/1040	30
KJ-503A-ESD	KJ-503B-ESD			rubber/tp	32						

### 04 螺杆插入式脚轮系列 Bushing Caster Series

Without Brake 不带刹	Brake 带刹	轮径D (mm)	丝杆外径 T	Material 轮子材质	Frame Material 支架材质	Offset DisancePIA 偏心距R(mm)	Loading 承重 (N)	长度 L(mm)	High/高 度H(mm)	Weight 单重 (g)	Package 每箱 ( pcs )
KJ-204A	KJ-204B	50mm	M12*35	pvc/pu/rubber	steel	22	300	35	67	193/240	100
KJ-204A-ESD	KJ-204B-ESD			rubber/tp		22					
KJ-304A	KJ-304B	75mm	M12*35	pvc/pu/rubber		35	500	35	95	450/550	50
KJ-304A-ESD	KJ-304B-ESD			rubber/tp		35					
KJ-404A	KJ-404B	100mm	M12*35	pvc/pu/rubber		32	600	35	132	600/750	40
KJ-404A-ESD	KJ-404B-ESD			rubber/tp	32						

## 脚杯/脚轮系列

## Adjust foot and Caster

K-1209A



K-1209B



K-1209C



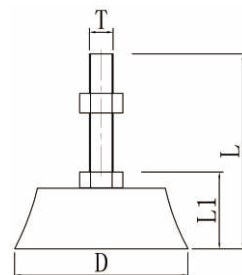
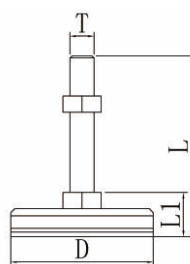
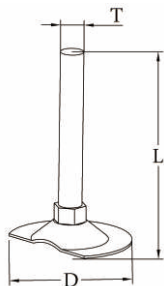
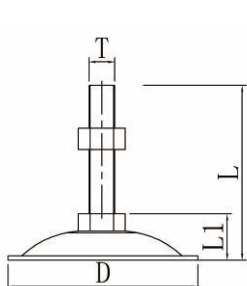

K-1200A





Code/型号	Stem Diameter 丝杆外径 ( T )	DIA/直径 D(mm)	Length/长度 L(mm)	Weight 单重 ( g )	Package 每箱 ( pcs )
K-1209A-1038	M10	38	60/80	45/52	100
K-1209A-1238	M12	38	60/80	48/56	100
K-1209A-1043	M10	43	60/80	50/60	100
K-1209A-1243	M12	43	60/80	55/63	100
K-1209A-1050	M10	50	60/80	60/68	100
K-1209A-1250	M12	50	60/80	66/73	100
K-1209A-1072	M10	72	80/100	69/76	100
K-1209A-1272	M12	72	80/100	75/83	100
K-1209B-1038	M10	38	60/80	43/50	100
K-1209B-1238	M12	38	60/80	46/52	100
K-1209B-1043	M10	43	60/80	49/57	100
K-1209B-1243	M12	43	60/80	54/61	100
K-1209B-1050	M10	50	60/80	58/65	100
K-1209B-1250	M12	50	60/80	60/67	100
K-1209B-1072	M10	72	80/100	65/73	100
K-1209B-1272	M12	72	80/100	71/79	100
K-1209C-1050	M10	50	60/80	71/80	100
K-1209C-1250	M12	50	60/80	88/95	100
K-1209C-1072	M10	72	80/100	95/103	100
K-1209C-1272	M12	72	80/100	105/112	100
K-1200A-1032	M10	32	60/80	65/73	100
K-1200A-1232	M12	32	60/80	70/78	100
K-1200A-1037	M10	37	60/80	74/82	100
K-1200A-1237	M12	37	60/80	81/89	100
K-1200A-1050	M10	50	60/80	82/90	100
K-1200A-1250	M12	50	60/80	86/95	100

## 附件 Tube Accessory

Part Number	Photo	Classification	Application	T1	T2	Weight(kg)	QTY(pcs)	Packaging(cm)
K-1209D1C-T07		Coated pipe	28*0.7	M10	M12	0.11	200	26*21*12
K-1209D1C-T08			28*0.8	M10	M12	0.095	200	26*21*12
K-1209D1C-T10			28*1.0	M10	M12	0.09	200	26*21*12
K-1209D1C-T12			28*1.2	M10	M12	0.08	200	26*21*12
K-1209D1C-T20			28*2.0	M10	M12	0.075	200	26*21*12
K-1209D1S-T07		Stainless pipe	28*0.7	M10	M12	0.11	200	26*21*12
K-1209D1S-T08			28*0.8	M10	M12	0.095	200	26*21*12
K-1209D1S-T10			28*1.0	M10	M12	0.09	200	26*21*12
K-1209D1S-T12			28*1.2	M10	M12	0.08	200	26*21*12

K-1209D2C-T07		Coated pipe	28*0.7	M10	M12	0.11	200	26*21*12
K-1209D2C-T10			28*1.0	M10	M12	0.095	200	26*21*12
K-1209D2S-T07		Stainless pipe	28*0.7	M10	M12	0.11	200	26*21*12
K-1209D2S-T10			28*1.0	M10	M12	0.095	200	26*21*12

Part Number	Photo	Classification	Application	Weight(kg)	QTY(pcs)	Packaging(cm)	Remark
K-110AC-07		Coated pipe	28*0.7	0.002	1000	35*28*15	
K-110AC-08			28*0.8	0.002	1000	35*28*15	
K-110AC-10			28*1.0	0.002	1000	35*28*15	
K-110AC-12			28*1.2	0.002	1000	35*28*15	
K-110BC-07		Coated pipe	28*0.7	0.002	1000	35*28*15	
K-110BC-08			28*0.8	0.002	1000	35*28*15	
K-110BC-10			28*1.0	0.002	1000	35*28*15	
K-110BC-12			28*1.2	0.002	1000	35*28*15	
K-110BC-20			28*2.0	0.002	1000	35*28*15	
K-110CS-07		Stainless pipe	28*0.7	0.002	1000	35*28*15	
K-110CS-08			28*0.8	0.002	1000	35*28*15	
K-110CS-10			28*1.0	0.002	1000	35*28*15	
K-110CS-12			28*1.2	0.002	1000	35*28*15	

### M6 NUT



Black ( BK )  
Zinc ( ZN )  
Nickel ( CN )

### M6\*25 BOLT



Black ( BK )  
Zinc ( ZN )  
Nickel ( CN )

### M6\*12 BOLT



Black ( BK )  
Zinc ( ZN )  
Nickel ( CN )

### M6\*28 BOLT



Black ( BK )  
Zinc ( ZN )  
Nickel ( CN )

### M6\*30 BOLT



Black ( BK )  
Zinc ( ZN )  
Nickel ( CN )

### M8\*40 BOLT NUT



### K-1200



### K-1200B

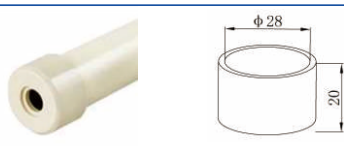

### K-1209E



附件  
Tube Accessory

KJ-1200A(M10 only)

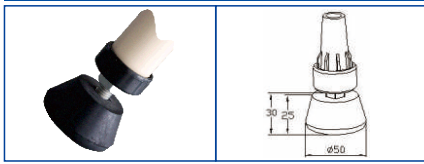

KJ-1200B

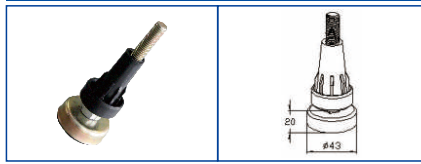

KJ-1200C(M10 only)

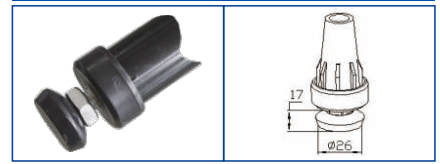

KJ-1200F(M8 only)

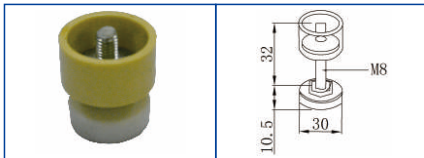

KJ-1200G(M8 only)



KJ-1209E(M10 only)

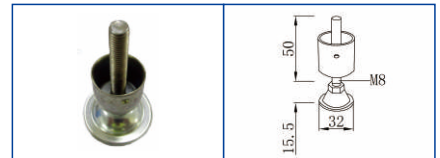

KJ-1209H(M10 only)



KJ-1209F(M10 only)

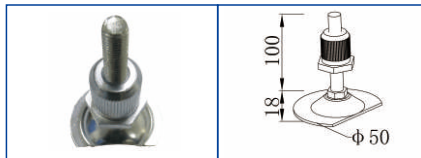

K-1209H



K-1209F



K-1209I



K-1209J

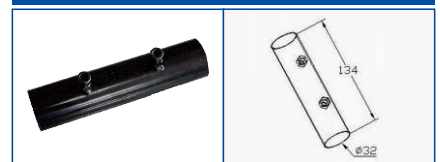

K-1209G

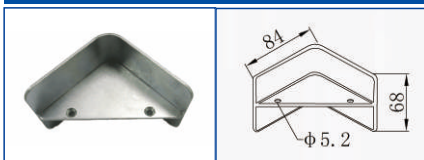

K-1000A(ZINC)

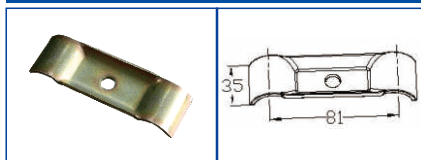

K-1000B(ZINC)

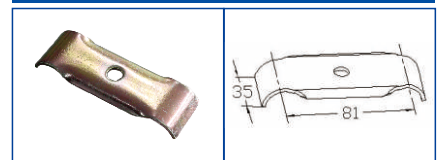

K-1000C(ZINC)

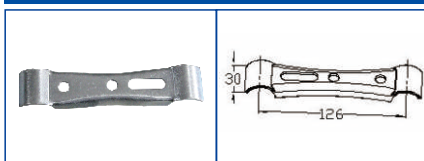

K-1000D(ZINC)

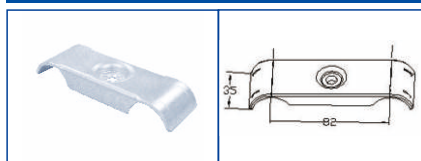

K-1002L

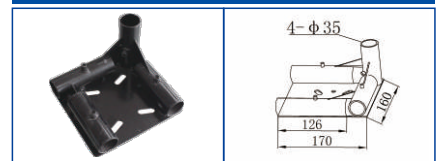

K-1002R

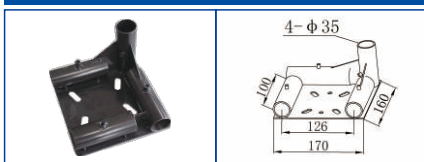

K-1003F

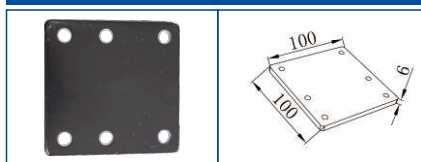

K-1003P

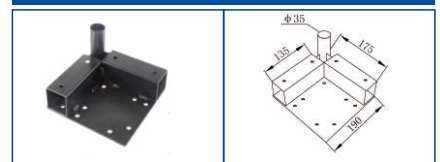

K-1003Y



K-1005A

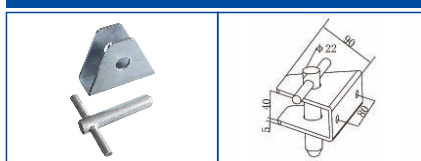

K-1005B

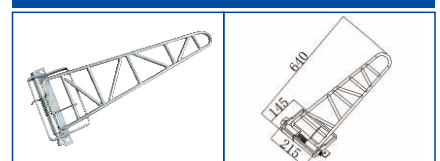

附件  
Tube Accessory

K-1006

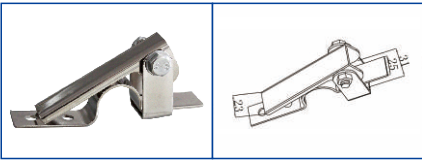

K-1007

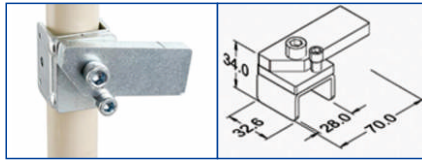

K-1008A

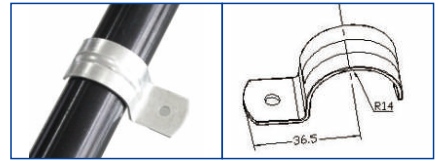

K-1008B

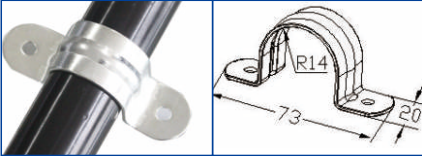

K-1008C

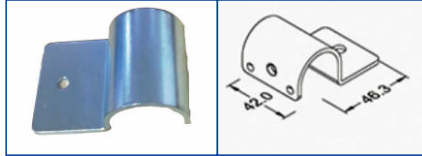

K-1009

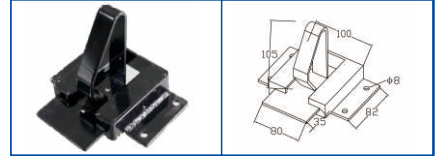

K-1011

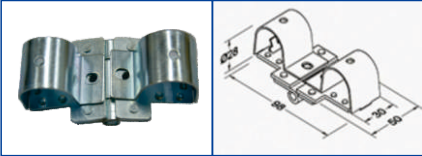

K-1012A

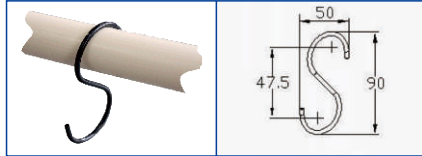

K-1012C



K-1012E

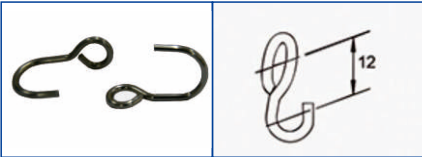

K-1012F



K-1012G

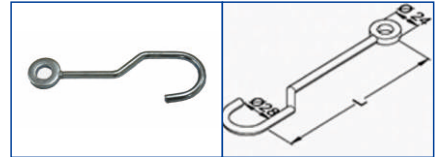

K-1012H



K-1012I

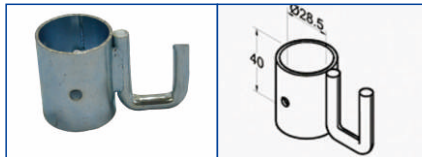

K-1012J

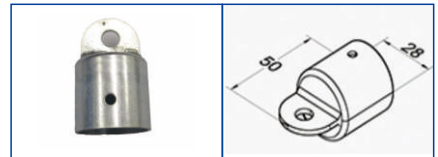

K-1012K

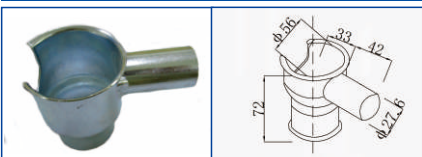

K-1012L

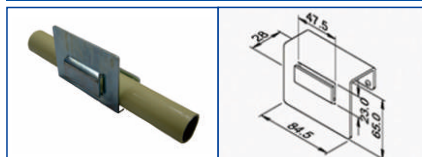

K-1012M

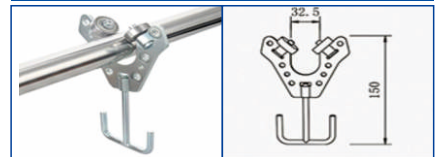

K-200 L:200/400/600MM

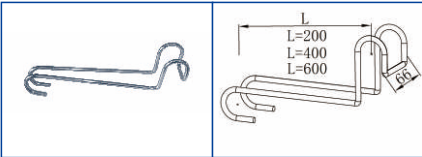

K-2080

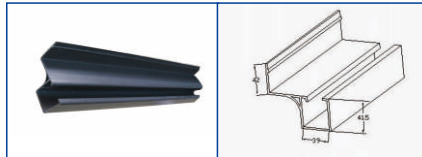

K-2081

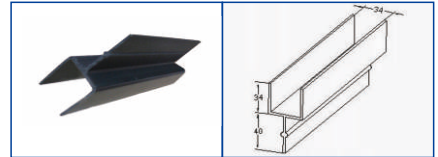

K-2080A

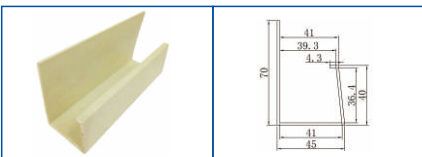

K-2080B

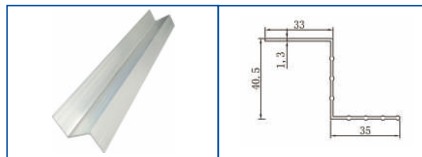

K-2081A

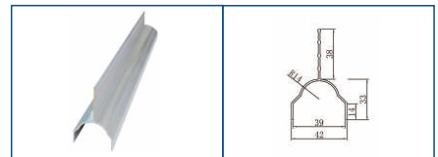

附件  
Tube Accessory



Item NO.	Specification (L*W*Hmm)	Item NO.	Specification (L*W*Hmm)
K-2087-BE	2000*25*25	K-01RD	OD:5-32mm , RD
K-2087-BE	2000*35*35	K-01BK	OD:5-32mm , BK
K-2087-BE	2000*35*40	K-02(wrench)	M5
K-2087-BE	2000*30*50	K-03(pipe cutter)	Cutting range 3-32
K-2087-BE	2000*50*60		

## 附件 Tube Accessory

### ESD MAT



### ESD PVC FILM

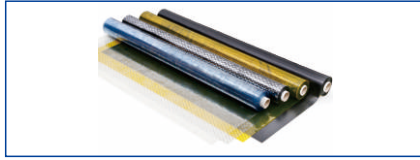

### PP Hollow sheet



Item NO.	Specification(Lm*Wm*T.mm)
J-102-Green	10*1*2,green
J-122-Green	10*1.2*2,green
J-103-Green	10*1*3,green
J-123-Green	10*1.2*3,green
J-102-Gray	10*1*2,gray
J-122-Gray	10*1.2*2,gray
J-103-Gray	10*1*3,gray
J-123-Gray	10*1.2*3,gray

Item NO.	Specification(Lm*Wm*T.mm)
J-3A	30*1.37*0.3Black
J-3B	30*1.37*0.3, transparent
J-5A	30*1.37*0.5,Black
J-5B	30*1.37*0.5, transparent

Item NO.	Specification(Lm*Wm*T.mm)
J-2	2.44*1.22*2,Any color/ESD
J-3	2.44*1.22*3,Any color/ESD
J-4	2.44*1.22*4,Any color/ESD
J-5	2.44*1.22*5,Any color/ESD
J-8	2.44*1.22*8,Any color/ESD
J-10	2.44*1.22*10,Any color/ESD

### J-A1

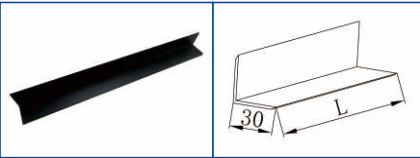

### J-B1

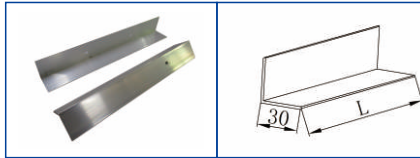

### J-A2-L

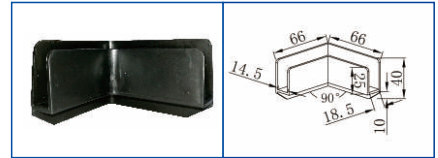

### J-A2-R

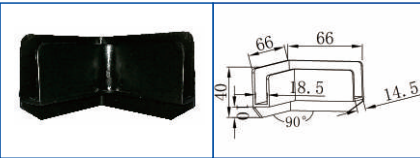

### J-A3-5

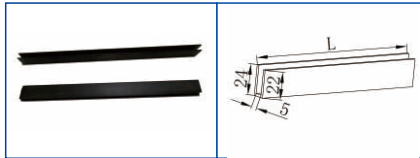

### J-A3-10

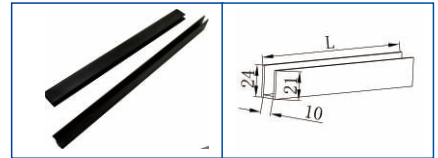

### J-B3-5

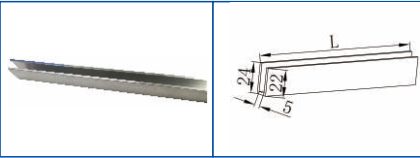

### J-B3-10

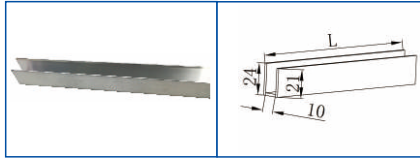

### J-A4

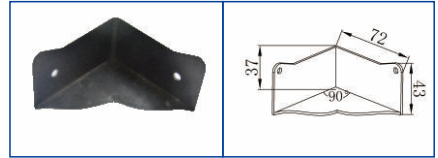

### J-B4

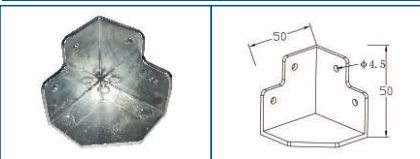

### J-A5



Material distinction : J-A series is plastic, and J-B series is aluminum alloy  
 ※.If have special Material, we can do it according customer sample, The MOQ is 1000PCS  
 ※"/" means no this product,"◎" means accept any quantity.

应用案例  
Applications

物流推车1

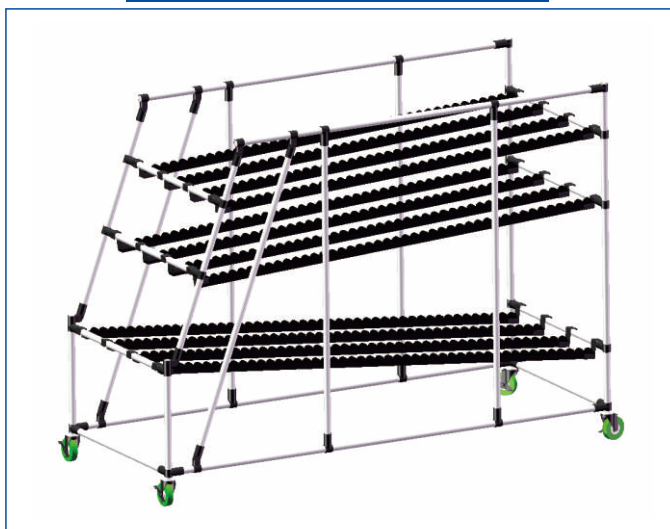

物流推车2



工具推车



钢网推车



分装推车



平板推车





应用案例  
Applications

玻璃车



精品推车



质量检测桌1



质量检测桌2

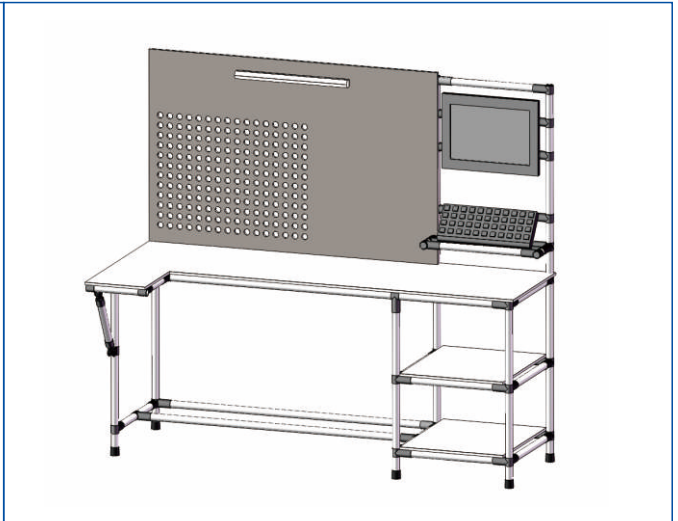

产品组装桌

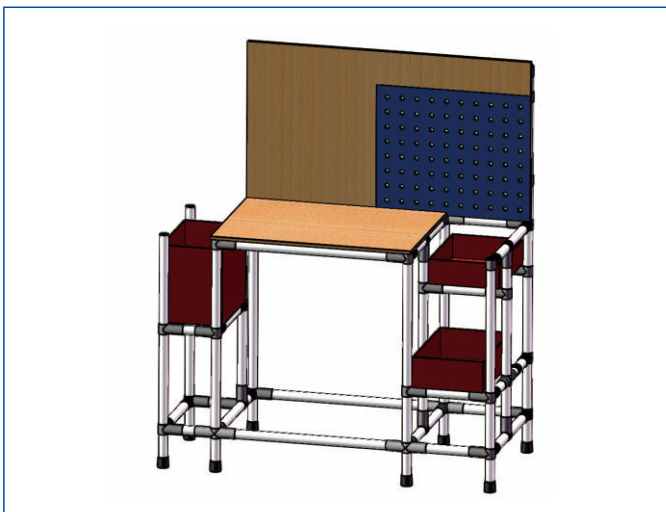

组装线生产桌

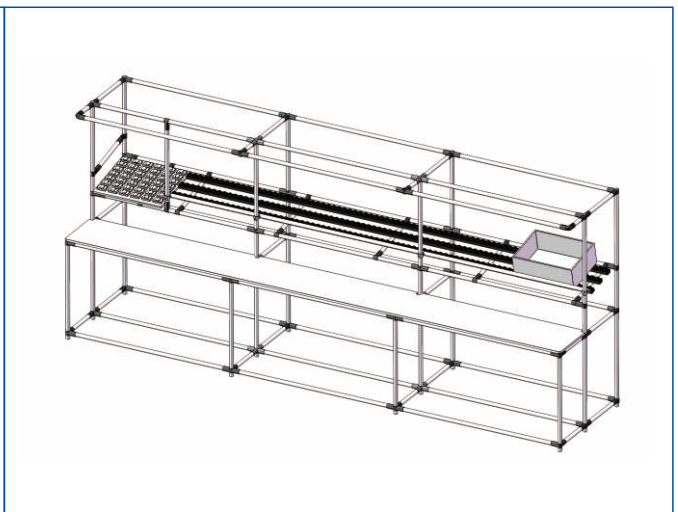

应用案例  
Applications

办公桌



工作桌



升降工作桌



储物架1

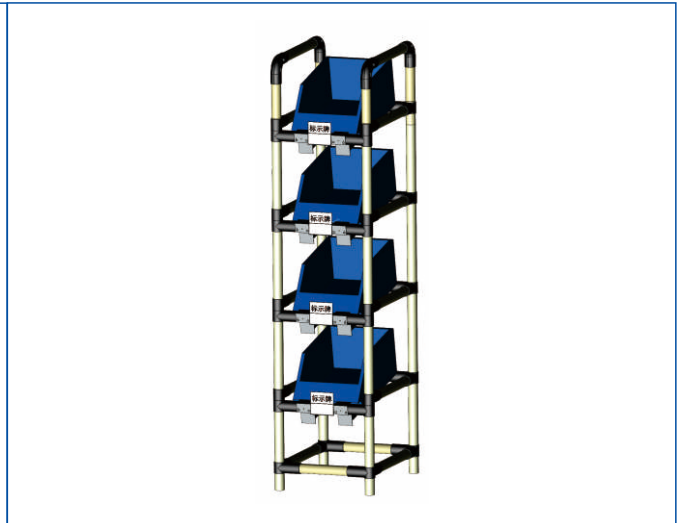

储物架2



翻转层放推车

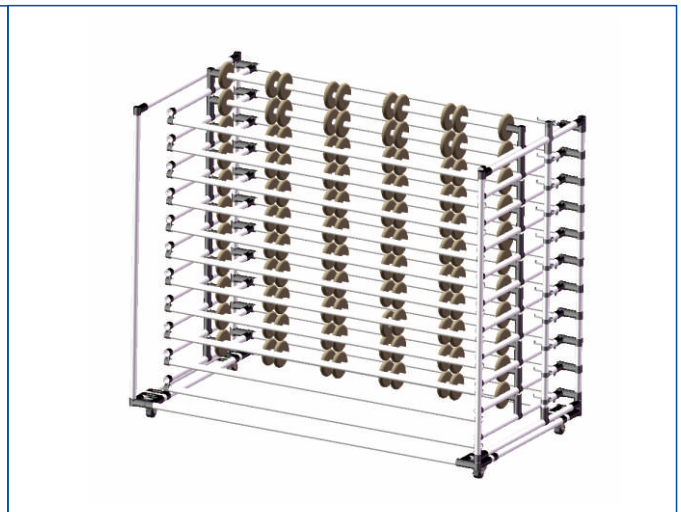

## 应用案例 Applications

卷料推车



零件架可移动型



灯光看板



灯光看板



晾衣架



储衣架

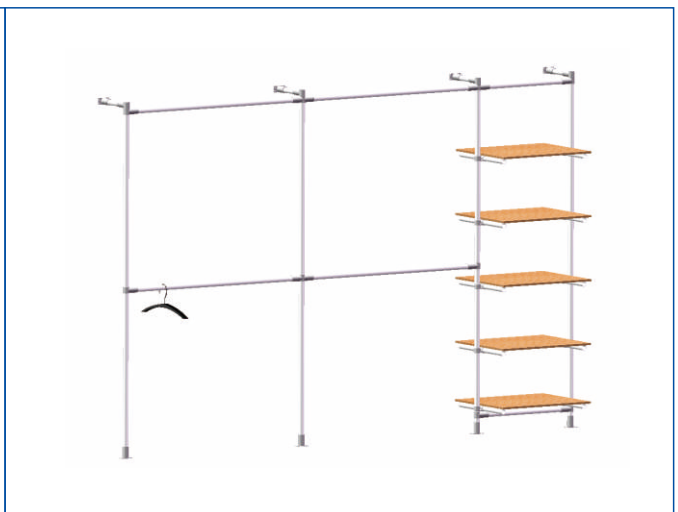



## King 9 Technology Company Limited

---

Add : NO.4 Building, Huayixiong Industrial Park, Songgang Town,  
Bao'an District, Shenzhen, Guangdong, China, 518105

Tel : ( 86 ) 755 2985 4361

Fax : ( 86 ) 755 2985 4361

Mail : [cnking9@cnking9.com](mailto:cnking9@cnking9.com)

Web : [www.cnking9.com](http://www.cnking9.com)